



CE-EMC TEST REPORT

Prepared for :

Yuyao Carzkool Appliances Of Autocar Co., Ltd.
6-1, Huangjianshan Ind. Zone, Yuyao City, Zhejiang Province, China 315400,
China

Product Name: Car Air Pump

Trade Mark: N/A

Product Model (S): CZK-3668, CZK-3634, CZK-3693,
CZK-5691, CZK-5625, CZK-3664,
CZK-3668P, CZK-3696, CZK-5621,
CZK-5622, CZK-5623, CZK-5624,
CZK-5626, CZK-5627, CZK-5628,
CZK-5629, CZK-5630, CZK-5641,
CZK-5642, CZK-5643, CZK-5644

Date of Test: Feb. 21, 2024 – Feb. 27, 2024

Date of Report: Feb. 27, 2024

Report Number: HK2402210724-1ER

Prepared By :

Shenzhen HUAK Testing Technology Co., Ltd.
1-2/F., Building B2, Junfeng Zhongcheng Zhizao Innovation Park, Heping,
Fuhai Street, Bao'an District, Shenzhen, Guangdong, China
TEL: +86-755-2302 9901 FAX: +86-755-2302 9901

E-mail: service@cer-mark.com <http://www.cer-mark.com>



TEST REPORT VERIFICATION

Applicant : Yuyao Carzkool Appliances Of Autocar Co., Ltd.
 Address : 6-1, Huangjianshan Ind. Zone, Yuyao City, Zhejiang Province, China 315400, China
 Manufacturer : Yuyao Carzkool Appliances Of Autocar Co., Ltd.
 Address : 6-1, Huangjianshan Ind. Zone, Yuyao City, Zhejiang Province, China 315400, China
 Product Name : Car Air Pump
 (A) Product Model : CZK-3668
 CZK-3634, CZK-3693, CZK-5691, CZK-5625, CZK-3664, CZK-3668P, CZK-3696, CZK-5621, CZK-5622, CZK-5623,
 (B) Series Model : CZK-5624, CZK-5626, CZK-5627, CZK-5628, CZK-5629, CZK-5630, CZK-5641, CZK-5642, CZK-5643, CZK-5644
 (C) Power Supply : DC 5V From Type-C or DC 7.4V From Battery

Standards..... EN IEC 55014-1:2021
 EN IEC 55014-2:2021
 EN 61000-4-2:2009
 EN IEC 61000-4-3:2020

This device described above has been tested by HUAK, and the test results show that the equipment under test (EUT) is in compliance with the 2014/30/EU requirements. And it is applicable only to the tested sample identified in the report.

This report shall not be reproduced except in full, without the written approval of HUAK, this document may be altered or revised by HUAK, personal only, and shall be noted in the revision of the document.

Test Result..... **Pass**

Date of Test: Feb. 21, 2024 – Feb. 27, 2024

Prepared by: Kevin Pan
 Project Engineer

Reviewed by: Stiver Wom
 Project Supervisor

Approved by: Jason Zhou
 Technical Director

**Table of Contents****Page**

1 . TEST SUMMARY	6
1.1 TEST FACILITY	7
1.2 MEASUREMENT UNCERTAINTY	7
2 . GENERAL INFORMATION	8
2.1 GENERAL DESCRIPTION OF EUT	8
2.2 DESCRIPTION OF TEST MODES	9
2.3 DESCRIPTION OF TEST SETUP	10
2.4 DESCRIPTION TEST PERIPHERAL AND EUT PERIPHERAL	11
2.5 MEASUREMENT INSTRUMENTS LIST	12
3 . EMC EMISSION TEST	14
3.1 CONDUCTED EMISSION MEASUREMENT	14
3.1.1 POWER LINE CONDUCTED EMISSION	14
3.1.2 MAINS TERMINALS OF TOOLS	14
3.1.3 TEST PROCEDURE	15
3.1.4 TEST SETUP	15
3.1.5 EUT OPERATING CONDITIONS	15
3.1.6 TEST RESULTS	16
3.2 RADIATED EMISSION MEASUREMENT	17
3.2.1 LIMITS OF RADIATED EMISSION MEASUREMENT	17
3.2.2 LIMITS OF DISTURBANCE POWER MEASUREMENT	17
3.2.3 TEST PROCEDURE	17
3.2.4 TEST SETUP	18
3.2.5 EUT OPERATING CONDITIONS	18
3.2.6 TEST RESULTS (30MHz ~300MHz)	19
3.2.7 TEST RESULTS (30MHz-1000MHz)	20
3.2.8 TEST RESULTS (1000MHz~6000MHz)	22
3.3 HARMONICS CURRENT	23
3.3.1 LIMITS OF HARMONICS CURRENT	23
3.3.1.1 TEST PROCEDURE	24
3.3.1.2 EUT OPERATING CONDITIONS	24
3.3.1.3 TEST SETUP	24
3.3.2 TEST RESULTS	25
3.4 VOLTAGE FLUCTUATION AND FLICKERS	26
3.4.1 LIMITS OF VOLTAGE FLUCTUATION AND FLICKERS	26
3.4.1.1 TEST PROCEDURE	26
3.4.1.2 EUT OPERATING CONDITIONS	26
3.4.1.3 TEST SETUP	26
3.4.2 TEST RESULTS	27
4 . EMC IMMUNITY TEST	28
4.1 STANDARD COMPLIANCE/SERVIRITY LEVEL/CRITERIA	28

The results shown in this test report refer only to the sample(s) tested unless otherwise stated and the sample(s) are retained for 30 days only. The document is issued by HUAK, this document cannot be reproduced except in full with our prior written permission. The more details and the authenticity of the report will be confirmed at <http://www.cer-mark.com>.

TEL : +86-755 2302 9901 FAX : +86-755 2302 9901 E-mail : service@cer-mark.com

Add: 1-2F., Building B2, Junfeng Zhongcheng Zhizao Innovation Park, Heping Community, Fuhai Street, Bao'an District, Shenzhen, Guangdong, China



Table of Contents	Page
4.2 GENERAL PERFORMANCE CRITERIA	29
4.3 GENERAL PERFORMANCE CRITERIA TEST SETUP	29
4.4 ESD TESTING	30
4.4.1 TEST SPECIFICATION	30
4.4.2 TEST PROCEDURE	30
4.4.3 TEST SETUP	31
4.4.4 TEST RESULTS	32
4.5 RS TESTING	33
4.5.1 TEST SPECIFICATION	33
4.5.2 TEST PROCEDURE	33
4.5.3 TEST SETUP	34
4.5.4 TEST RESULTS	35
4.6 EFT/BURST TESTING	36
4.6.1 TEST SPECIFICATION	36
4.6.2 TEST PROCEDURE	36
4.6.3 TEST SETUP	37
4.6.4 TEST RESULTS	38
4.7 SURGE TESTING	39
4.7.1 TEST SPECIFICATION	39
4.7.2 TEST PROCEDURE	39
4.7.3 TEST SETUP	40
4.7.4 TEST RESULTS	41
4.8 INJECTION CURRENT TESTING	42
4.8.1 TEST SPECIFICATION	42
4.8.2 TEST PROCEDURE	42
4.8.3 TEST SETUP	43
4.8.4 TEST RESULTS	44
4.9 VOLTAGE INTERRUPTION/DIPS TESTING	45
4.9.1 TEST SPECIFICATION	45
4.9.2 TEST PROCEDURE	45
4.9.3 TEST SETUP	45
4.9.4 TEST RESULTS	46
5 . EUT TEST PHOTO	47
ATTACHMENT PHOTOGRAPHS OF EUT	49



**** Modified History ****

Revision	Description	Issued Data	Remark
Revision 1.0	Initial Test Report Release	2024/02/27	Jason Zhou



1. TEST SUMMARY

Test procedures according to the technical standards:

EMC Emission				
Standard	Test Item	Limit	Judgment	Remark
EN IEC 55014-1	Conducted Emission	Clause 4.3.3.6	N/A	
	Disturbance Power	Clause 4.3.4.4	PASS	
	Radiated Emission	Clause 4.3.4.5	PASS	
EN IEC 61000-3-2	Harmonic Current Emission	Class A	N/A	
EN 61000-3-3	Voltage Fluctuations & Flicker	-----	N/A	
EMC Immunity				
Section	Test Item	Performance Criteria	Judgment	Remark
EN IEC 55014-2				
EN 61000-4-2	Electrostatic Discharge	B	PASS	
EN IEC 61000-4-3	RF electromagnetic field	A	PASS	
EN 61000-4-4	Fast transients	B	N/A	
EN 61000-4-5	Surges	B	N/A	
EN 61000-4-6	Injected currents	A	N/A	
EN IEC 61000-4-11	Volt. Interruptions Volt. Dips	C / C / C NOTE (2)	N/A	

NOTE:

- (1) "N/A" denotes test is not applicable in this Test Report
- (2) Voltage dip: 0% reduction – Performance Criteria **C**
Voltage dip: 30% reduction – Performance Criteria **C**
Voltage dip: 60% reduction – Performance Criteria **C**
- (3) For client's request and manual description, the test will not be executed.



1.1 TEST FACILITY

Shenzhen HUAK Testing Technology Co., Ltd.
Address: 1-2/F., Building B2, Junfeng Zhongcheng Zhizao Innovation Park, Heping, Fuhai Street, Bao'an District, Shenzhen, Guangdong, China

Testing Laboratory Authorization :
A2LA Accreditation Code is 4781.01.
FCC Designation Number is CN1229.
Canada IC CAB identifier is CN0045.
CNAS Registration Number is L9589.

1.2 MEASUREMENT UNCERTAINTY

The reported uncertainty of measurement y ± U , where expended uncertainty U is based on a standard uncertainty multiplied by a coverage factor of k=2 , providing a level of confidence of approximately 95 % .

A. Conducted Measurement :

Table with 3 columns: Measurement Frequency Range, Uncertainty, NOTE. Row 1: 150 KHz ~ 30MHz, ±2.71dB

B. Radiated Measurement :

Table with 3 columns: Measurement Frequency Range, Uncertainty, NOTE. Row 1: 30MHz ~ 1000MHz, ±3.90dB. Row 2: 1GHz ~6GHz, ±4.28dB

C. Disturbance Power Measurement:

Table with 3 columns: Measurement Frequency Range, Uncertainty, NOTE. Row 1: 30MHz ~300MHz, ±3.35dB



2. GENERAL INFORMATION

2.1 GENERAL DESCRIPTION OF EUT

Product Name	Car Air Pump	
Product Model	CZK-3668	
Series Model	CZK-3634, CZK-3693, CZK-5691, CZK-5625, CZK-3664, CZK-3668P, CZK-3696, CZK-5621, CZK-5622, CZK-5623, CZK-5624, CZK-5626, CZK-5627, CZK-5628, CZK-5629, CZK-5630, CZK-5641, CZK-5642, CZK-5643, CZK-5644	
Model Difference	All model's the function, software and electric circuit are the same, only with a product color and model named different. Test sample model: CZK-3668.	
Product Description	The EUT is a Car Air Pump.	
	Operating frequency:	N/A
	Connecting I/O port:	N/A
	Based on the application, features, or specification exhibited in User's Manual, the EUT is considered as an ITE/Computing Device. More details of EUT technical specification, please refer to the User's Manual.	
Power Source	DC Voltage	
Power Rating	DC 5V From Type-C or DC 7.4V From Battery	



2.2 DESCRIPTION OF TEST MODES

To investigate the maximum EMI emission characteristics generates from EUT, the test system was pre-scanning tested base on the consideration of following EUT operation mode or test configuration mode which possible have effect on EMI emission level. Each of these EUT operation mode(s) or test configuration mode(s) mentioned above was evaluated respectively.

Pretest Mode	Description
Mode 1	Charging and Working
Mode 2	Charging
Mode 3	Working

For Conducted Test	
Final Test Mode	Description
Mode 1	N/A

For Disturbance Power Test	
Final Test Mode	Description
Mode 1	Charging and Working
Mode 2	Charging
Mode 3	N/A

For Radiated Test	
Final Test Mode	Description
Mode 1	Charging and Working
Mode 2	Charging
Mode 3	Working

For EMS Test	
Final Test Mode	Description
Mode 1	Charging and Working
Mode 2	Charging
Mode 3	Working

The results shown in this test report refer only to the sample(s) tested unless otherwise stated and the sample(s) are retained for 30 days only. The document is issued by HUAK, this document cannot be reproduced except in full with our prior written permission. The more details and the authenticity of the report will be confirmed at <http://www.cer-mark.com>.



2.3 DESCRIPTION OF TEST SETUP

Mode 1:



Mode 2:

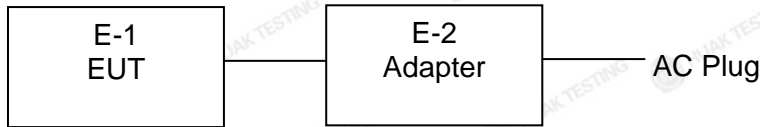

Mode 3:

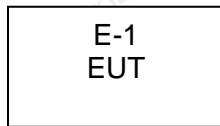



2.4 DESCRIPTION TEST PERIPHERAL AND EUT PERIPHERAL

The EUT has been tested as an independent unit together with other necessary accessories or support units. The following support units or accessories were used to form a representative test configuration during the tests.

Item	Equipment	Trade Mark	Model/Type No.	Series No.	Note
E-1	Car Air Pump	N/A	CZK-3668	N/A	EUT
E-2	Adapter	HUAWEI	HW-050450C00	N/A	

Item	Shielded Type	Ferrite Core	Length	Note

Note:

- (1) The support equipment was authorized by Declaration of Confirmation.
- (2) For detachable type I/O cable should be specified the length in cm in 『Length』 column.
- (3) “YES” is means “shielded” “with core”; “NO” is means “unshielded” “without core”.

**2.5 MEASUREMENT INSTRUMENTS LIST****2.5.1 CONDUCTED TEST SITE**

Item	Kind of Equipment	Manufacturer	Type No.	Serial No.	Calibrated until
1	LISN	R&S	ENV216	HKE-002	Feb. 19, 2025
2	LISN	R&S	ENV216	HKE-059	Feb. 19, 2025
3	EMI Test Receiver	R&S	ESR-7	HKE-010	Feb. 19, 2025

2.5.2 RADIATED TEST SITE

Item	Kind of Equipment	Manufacturer	Type No.	Serial No.	Calibrated until
1	Broadband antenna	Schwarzbeck	VULB 9163	HKE-012	Feb. 19, 2026
2	Horn antenna	Schwarzbeck	9120D	HKE-013	Feb. 19, 2026
3	EMI Test Receiver	R&S	ESR-7	HKE-010	Feb. 19, 2025
4	Spectrum Analyzer	Agilent	N9020A	HKE-048	Feb. 19, 2025
5	Amplifier	Schwarzbeck	EMC051845 SE	HKE-015	Feb. 19, 2025
6	Amplifier	Agilent	83051A	HKE-016	Feb. 19, 2025

2.5.3 Disturbance Power TEST SITE

Item	Kind of Equipment	Manufacturer	Type No.	Serial No.	Calibrated until
1	EMI Test Receiver	R&S	ESR-7	HKE-010	Feb. 19, 2025
2	6DB Attenuator	Pasternack	6db	HKE-007	Feb. 19, 2025
3	Electromagnetic absorbing clamp	R&S	MDS 21	HKE-008	Feb. 19, 2025

2.5.4 HARMONICS AND FILCK

Item	Kind of Equipment	Manufacturer	Type No.	Serial No.	Calibrated until
1	Harmonic flicker tester	California Instruments	AC2000A	HKE-037	Feb. 19, 2025

2.5.5 ESD

Item	Kind of Equipment	Manufacturer	Type No.	Serial No.	Calibrated until
1	ESD device	Schloder	SESD 216	HKE-023	Feb. 19, 2025

**2.5.6 RS**

Item	Kind of Equipment	Manufacturer	Type No.	Serial No.	Calibrated until
1	Power amplifier	Vectawave	100W1000M7	HKE-142	Feb. 19, 2025
2	Power amplifier	Vectawave	MPA-1000-600 0-100	HKE-143	Feb. 19, 2025
3	Power Meter	KEYSIGHT	E4419B	HKE-144	Feb. 19, 2025
4	Signal Generator	Agilent	N5181A	HKE-145	Feb. 19, 2025
5	Field intensity probe	PMM	EP601	HKE-146	Feb. 19, 2025
6	High gain antenna	Schwarzbeck	STPL9149	HKE-147	Feb. 19, 2026

2.5.7 SURGE, EFT/BURST, VOLTAGE INTERRUPTION/DIPS

Item	Kind of Equipment	Manufacturer	Type No.	Serial No.	Calibrated until
1	Full-featured immunity tester	HTEC	HV1P16T	HKE-017	Feb. 19, 2025

2.5.8 INJECTION CURRENT

Item	Kind of Equipment	Manufacturer	Type No.	Serial No.	Calibrated until
1	Magnetic clamp	EMCL	EMCL-20	HKE-032	Feb. 19, 2025
2	Integrated Conduction Sensitivity Test System	Schloder	CDG6000	HKE-033	Feb. 19, 2025

2.5.8 MF

Item	Kind of Equipment	Manufacturer	Type No.	Serial No.	Calibrated until
1	Power frequency induction coil	HTEC Instruments Ltd.	HPFMF	HKE-049	Feb. 19, 2025



3. EMC EMISSION TEST

3.1 CONDUCTED EMISSION MEASUREMENT

3.1.1 POWER LINE CONDUCTED EMISSION (Frequency Range 150KHz-30MHz)

Frequency Range (MHz)	At mains terminals	
	Quasi-peak (dBuV)	Average (dBuV)
0.15 -0.5	66 - 56 *	59 - 46 *
0.50 -5.0	56.00	46.00
5.0 -30.0	60.00	50.00

3.1.2 MAINS TERMINALS OF TOOLS

Frequency Range (MHz)	Rated motor power not exceeding 700W		Rated motor power above 700W and not exceeding 1 000 W		Rated motor power above 1 000 W	
	dB (uV) Quasi-peak	dB (uV) Average**	dB (uV) Quasi-peak	dB (uV) Average**	dB (uV) Quasi-peak	dB (uV) Average**
0.15 -0.5	66.0 to 59.0*	59.0 to 49.0*	70.0 to 63.0*	63.0 to 53.0*	76.0 to 69.0*	69.0 to 59.0*
0.50 -5.0	59.0	49.0	63.0	53.0	69.0	59.0
5.0 -30.0	64.0	54.0	68.0	58.0	74.0	64.0

Note:

- (1) The tighter limit applies at the band edges.
- (2) The limit of " * " marked band means the limitation decreases linearly with the logarithm of the frequency in the range.
- (3) "***" If the limit for the measurement with the average detector is met when using a receiver with a quasi-peak detector, the equipment under test shall be deemed to meet both limits and the measurement using the receiver with an average detector need not be carried out.

The following table is the setting of the receiver

Receiver Parameters	Setting
Attenuation	10 dB
Start Frequency	0.15 MHz
Stop Frequency	30 MHz
IF Bandwidth	9 kHz

3.1.3 TEST PROCEDURE

- The EUT was placed 0.4 meters from the horizontal ground plane with EUT being connected to the power mains through a line impedance stabilization network (LISN). All other support equipments powered from additional LISN(s). The LISN provide 50 Ohm/ 50uH of coupling impedance for the measuring instrument.
- Interconnecting cables that hang closer than 40 cm to the ground plane shall be folded back and forth in the center forming a bundle 30 to 40 cm long.
- I/O cables that are not connected to a peripheral shall be bundled in the center. The end of the cable may be terminated, if required, using the correct terminating impedance. The overall length shall not exceed 1 m.
- LISN at least 80 cm from nearest part of EUT chassis.
- For the actual test configuration, please refer to the related Item –EUT Test Photos.

3.1.4 TEST SETUP

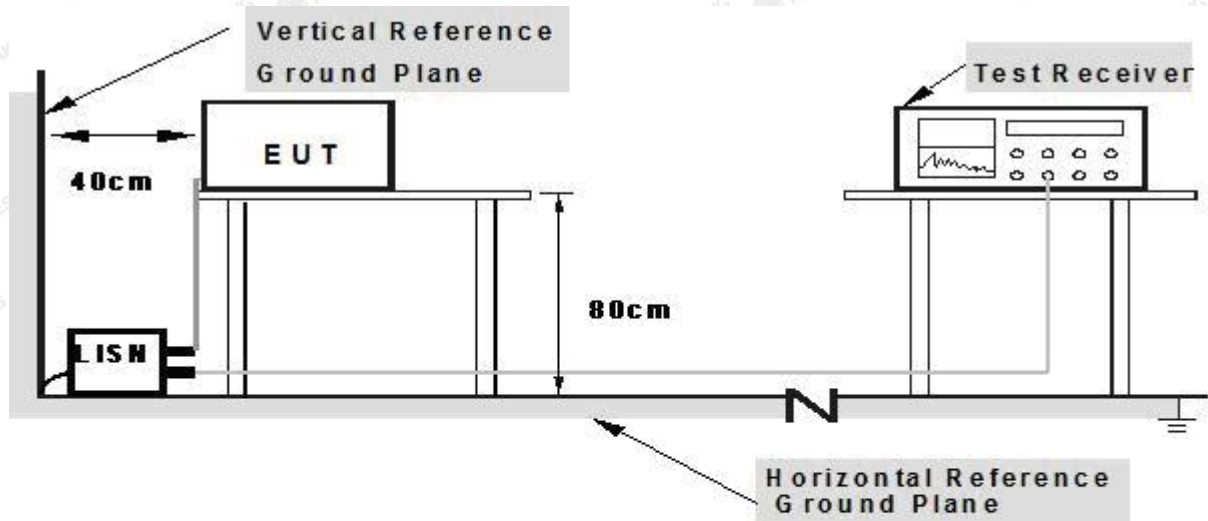

Note: 1. Support units were connected to second LISN.

2. Both of LISNs (AMN) are 80 cm from EUT and at least 80 cm from other units and other metal planes

3.1.5 EUT OPERATING CONDITIONS

The EUT tested system was configured as the statements of 2.3 Unless otherwise a special operating condition is specified in the follows during the testing.



3.1.6 TEST RESULTS

EUT :	Car Air Pump	Model Name :	CZK-3668
Temperature :	N/A	Relative Humidity :	N/A
Pressure :	N/A	Test Date :	N/A
Test Mode :	N/A	Phase :	N/A
Test Voltage :	N/A		
Note: EUT is test by DC power supply, so this test report is not applicable.			



3.2 RADIATED EMISSION MEASUREMENT

3.2.1 LIMITS OF RADIATED EMISSION MEASUREMENT (Below 1000MHz)

FREQUENCY (MHz)	At 10m	At 3m
	dBuV/m	dBuV/m
30 – 230	30	40
230 – 1000	37	47

3.2.2 LIMITS OF DISTURBANCE POWER MEASUREMENT (Below 1000MHz)

Frequency Range (MHz)	Household and similar appliances		Tools			
	dB (pW) Quasi-peak	dB (pW) Averag*	Rated motor power not exceeding 700 W		Rated motor power above 700 W and not exceeding 1 000 W	
(MHz)	dB (pW) Quasi-peak	dB (pW) Averag*	dB (pW) Quasi-peak	dB (pW) Averag*	dB (pW) Quasi-peak	dB (pW) Averag*
30-300	45-55	35-45	45-55	35-45	49-59	39-49

Notes:

- (1) The limit for radiated test was performed according to as following: CISPR 14.
- (2) The tighter limit applies at the band edges.
- (3) Emission level (dBuV/m)=20log Emission level (uV/m).

3.2.3 TEST PROCEDURE

- a. The measuring distance of at 10 m shall be used for measurements at frequency up to 1GHz. For frequencies above 1GHz, any suitable measuring distance may be used.
- b. The EUT was placed on the top of a rotating table 0.8 meters above the ground at a 10 meter open area test site. The table was rotated 360 degrees to determine the position of the highest radiation.
- c. The height of the equipment or of the substitution antenna shall be 0.8 m; the height of the test antenna shall vary between 1 m to 4 m. Both horizontal and vertical polarizations of the antenna are set to make the measurement.
- d. The initial step in collecting conducted emission data is a spectrum analyzer peak detector mode pre-scanning the measurement frequency range. Significant peaks are then marked and then Quasi Peak detector mode re-measured, above 1G Average detector mode will be instead.
- e. If the Peak Mode measured value compliance with and lower than Quasi Peak Mode Limit, the EUT shall be deemed to meet QP(AV) Limits and then no additional QP Mode measurement performed.
- f. For the actual test configuration, please refer to the related Item –EUT Test Photos.

3.2.4 TEST SETUP

(A) Radiated Emission Test Set-Up Frequency Below 1 GHz

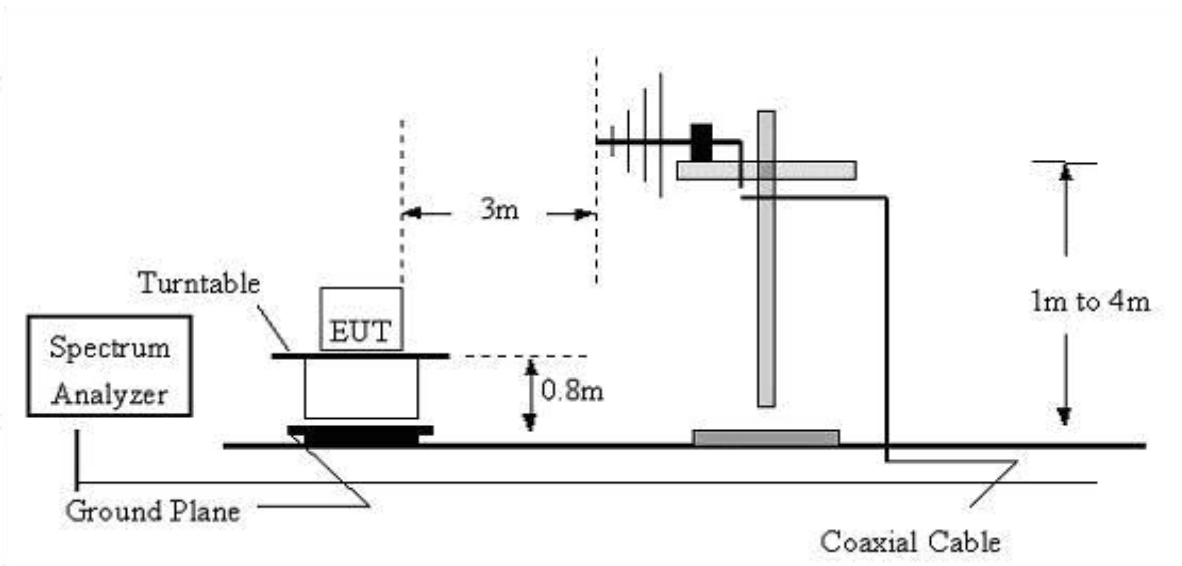

(B) Disturbance Power Test Set-UP Frequency Below 1GHz

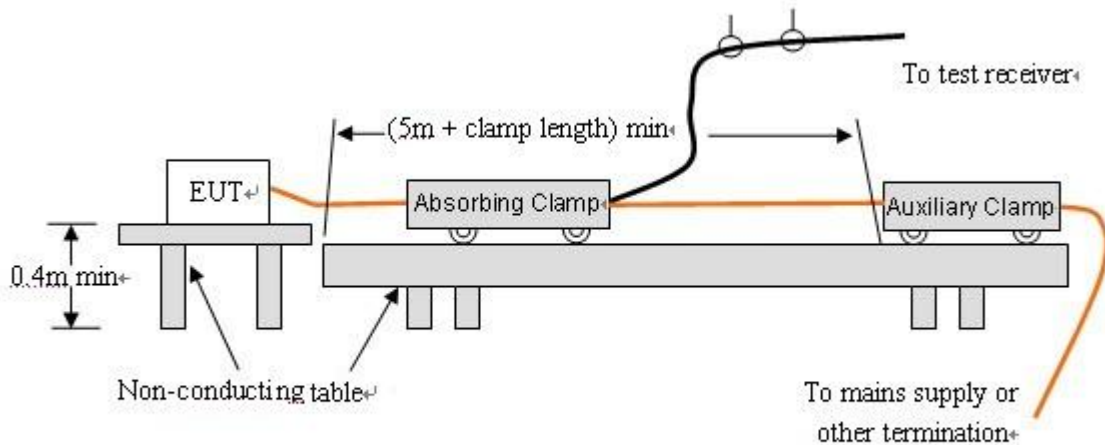

3.2.5 EUT OPERATING CONDITIONS

The EUT tested system was configured as the statements of **2.3** Unless otherwise a special operating condition is specified in the follows during the testing.



3.2.6 TEST RESULTS (30MHz ~300MHz)

Note:

All the test modes completed for test. only the worst result of was reported.

EUT :	Car Air Pump	Model Name :	CZK-3668
Temperature :	24 °C	Relative Humidity :	54%
Pressure :	1010 hPa	Test Date :	2024-02-22
Test Mode :	Mode 1		
Test Power :	DC 5V From Type-C		

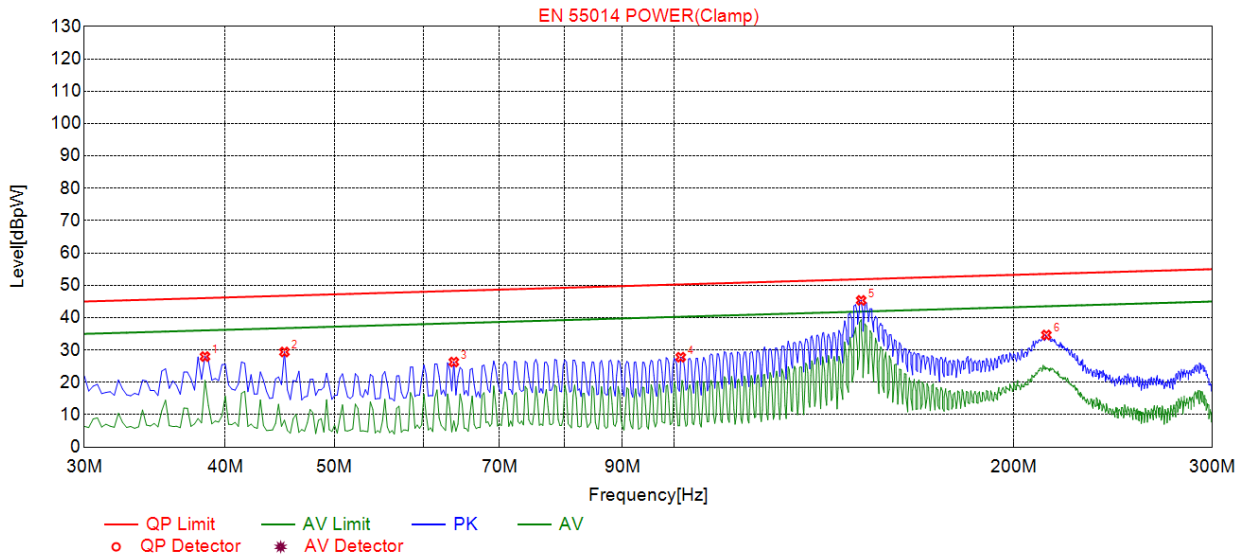

Suspected List								
NO.	Freq. [MHz]	Level[d Bpw]	Factor [dB]	Reading [dBpW]	Limit [dBpw]	Margin [dB]	Detector	Type
1	38.3784	27.99	7.71	34.28	46.07	18.08	PK	Clamp
2	45.1351	29.40	5.51	37.89	46.77	17.37	PK	Clamp
3	63.7838	26.30	5.72	34.58	48.28	21.98	PK	Clamp
4	101.3514	27.79	4.63	37.16	50.29	22.50	PK	Clamp
5	146.4865	45.35	3.65	55.70	51.89	6.54	PK	Clamp
6	213.7838	34.66	2.80	45.86	53.53	18.87	PK	Clamp

Remark: Margin = Limit – Level

Correction factor = Cable lose + insertion loss

Level=Test receiver reading + correction factor



3.2.7 TEST RESULTS (30MHz-1000MHz)

Note:

All the test modes completed for test. only the worst result of was reported.

EUT :	Car Air Pump	Model Name :	CZK-3668
Temperature :	24 °C	Relative Humidity :	54%
Pressure :	1010 hPa	Test Date :	2024-02-22
Test Mode :	Mode 3	Polarization :	Horizontal
Test Power :	DC 7.4V From Battery		

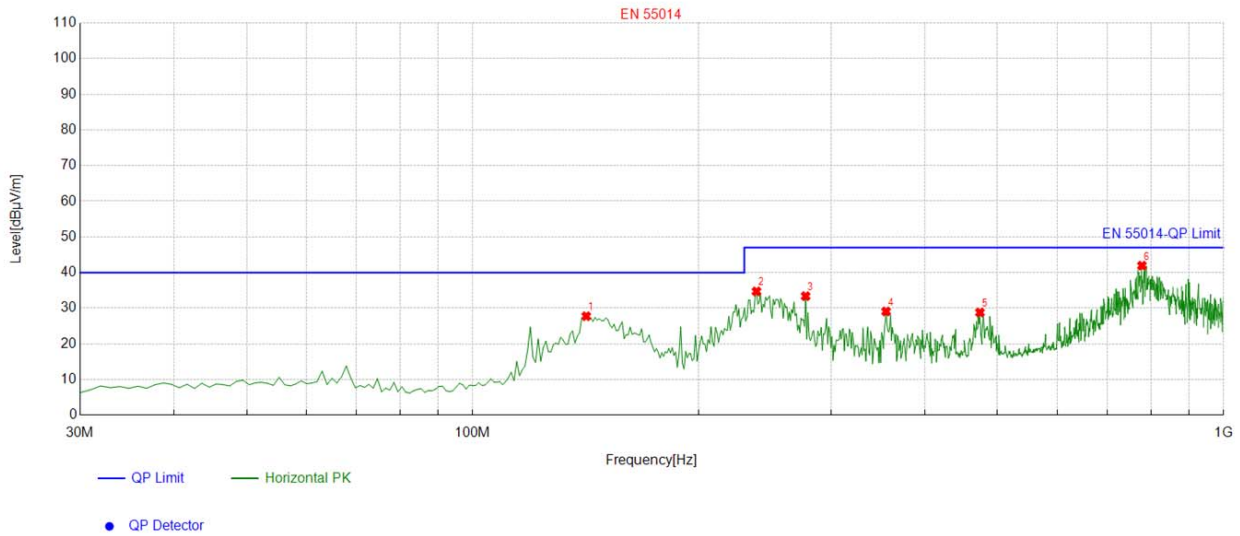

Suspected List									
NO.	Freq. [MHz]	Factor [dB]	Reading [dBµV/m]	Level [dBµV/m]	Limit [dBµV/m]	Margin [dB]	Height [cm]	Angle [°]	Polarity
1	141.66166	-18.11	45.86	27.75	40.00	12.25	100	358	Horizontal
2	238.75875	-13.34	48.06	34.72	47.00	12.28	100	33	Horizontal
3	277.59759	-12.57	45.95	33.38	47.00	13.62	100	1	Horizontal
4	355.27527	-11.04	40.13	29.09	47.00	17.91	100	19	Horizontal
5	473.73373	-7.95	36.76	28.81	47.00	18.19	100	177	Horizontal
6	778.61861	-2.40	44.34	41.94	47.00	5.06	100	228	Horizontal

Final Data List

Remark: Factor = Cable loss + Antenna factor – Pre-amplifier; Level = Reading + Factor, Margin = Limit – Level;



EUT :	Car Air Pump	Model Name :	CZK-3668
Temperature :	24 °C	Relative Humidity :	54%
Pressure :	1010 hPa	Test Date :	2024-02-22
Test Mode :	Mode 3	Polarization :	Vertical
Test Power :	DC 7.4V From Battery		

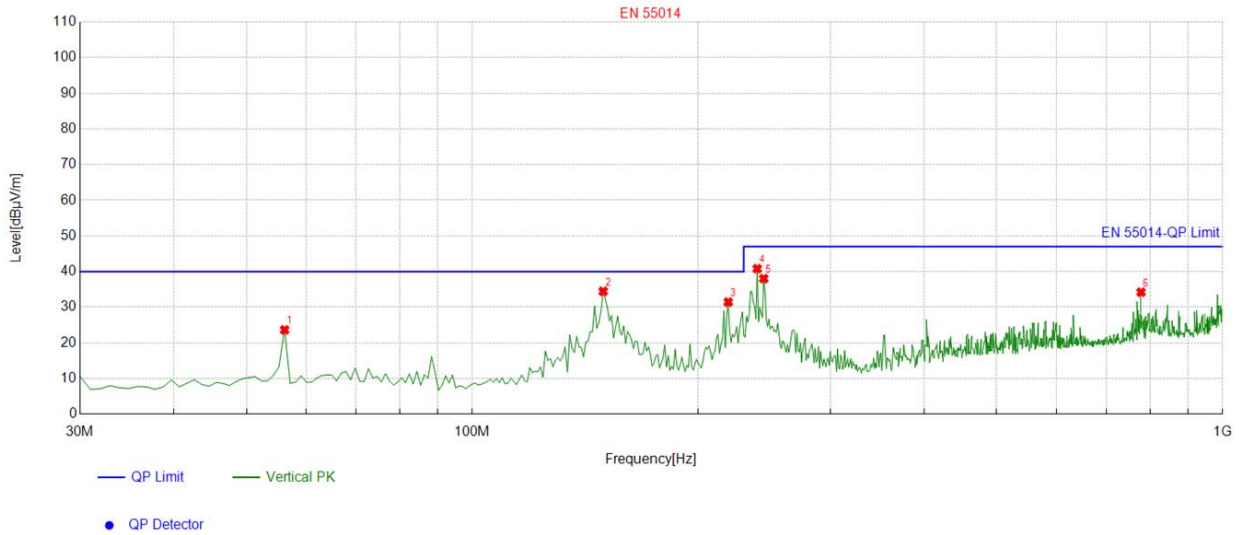

Suspected List									
NO.	Freq. [MHz]	Factor [dB]	Reading [dBµV/m]	Level [dBµV/m]	Limit [dBµV/m]	Margin [dB]	Height [cm]	Angle [°]	Polarity
1	56.216216	-14.40	38.05	23.65	40.00	16.35	100	359	Vertical
2	149.42942	-18.78	53.23	34.45	40.00	5.55	100	227	Vertical
3	219.33933	-14.30	45.74	31.44	40.00	8.56	100	358	Vertical
4	239.72973	-13.31	54.12	40.81	47.00	6.19	100	207	Vertical
5	244.58458	-13.27	51.29	38.02	47.00	8.98	100	214	Vertical
6	778.61861	-2.40	36.62	34.22	47.00	12.78	100	330	Vertical

Final Data List

Remark: Factor = Cable loss + Antenna factor – Pre-amplifier; Level = Reading + Factor, Margin = Limit – Level;



3.2.8 TEST RESULTS (1000MHz~6000MHz)

EUT :	Car Air Pump	Model Name :	CZK-3668
Temperature :	N/A	Relative Humidity :	N/A
Pressure :	N/A	Test Date :	N/A
Test Mode :	N/A	Polarization :	N/A
Test Power :	N/A		
Note: EUT high frequency is less than 108MHz, so this test report is not applicable.			



3.3 HARMONICS CURRENT

3.3.1 LIMITS OF HARMONICS CURRENT

IEC 555-2					
Table - I			Table - II		
Equipment Category	Harmonic Order n	Max. Permissible Harmonic Current (in Amperes)	Equipment Category	Harmonic Order n	Max. Permissible Harmonic Current (in Amperes)
Non Portable Tools or TV Receivers	Odd Harmonics		TV Receivers	Odd Harmonics	
	3	2.30		3	0.80
	5	1.14		5	0.60
	7	0.77		7	0.45
	9	0.40		9	0.30
	11	0.33		11	0.17
	13	0.21		13	0.12
	15 ≤ n ≤ 39	0.15 · 15/n		15 ≤ n ≤ 39	0.10 · 15/n
	Even Harmonics			Even Harmonics	
	2	1.08		2	0.30
4	0.43	4	0.15		
8	0.30				
8 ≤ n ≤ 40	0.23 · 8/n	DC	0.05		

EN 61000-3-2/IEC 61000-3-2					
Equipment Category	Max. Permissible Harmonic Current (in Amperes)	Equipment Category	Harmonic Order n	Max. Permissible Harmonic Current (in A)	Max. Permissible Harmonic Current (mA/w)
Class A	Same as Limits Specified in 4-2.1, Table - I, but only odd harmonics required	Class D	3	2.30	3.4
			5	1.14	1.9
			7	0.77	1.0
			9	0.40	0.5
			11	0.33	0.35
			13 ≤ n ≤ 39	see Table I	3.85/n
only odd harmonics required					

The results shown in this test report refer only to the sample(s) tested unless otherwise stated and the sample(s) are retained for 30 days only. The document is issued by HUAK, this document cannot be reproduced except in full with our prior written permission. The more details and the authenticity of the report will be confirmed at <http://www.cer-mark.com>.

3.3.1.1 TEST PROCEDURE

a. The EUT was placed on the top of a wooden table 0.8 meters above the ground and operated to produce the maximum harmonic components under normal operating conditions.

b. The classification of EUT is according to section 5 of EN 61000-3-2. The EUT is classified as follows:

Class A: Balanced three-phase equipment, Household appliances excluding equipment as Class D, Tools excluding portable tools, Dimmers for incandescent lamps, audio equipment, equipment not specified in one of the three other classes.

Class B: Portable tools. Portable tools.; Arc welding equipment which is not professional equipment.

Class C: Lighting equipment.

Class D: Equipment having a specified power less than or equal to 600 W of the following types: Personal computers and personal computer monitors and television receivers.

c. The correspondent test program of test instrument to measure the current harmonics emanated from EUT is chosen. The measure time shall be not less than the time necessary for the EUT to be exercised.

3.3.1.2 EUT OPERATING CONDITIONS

The EUT tested system was configured as the statements of **2.3** Unless otherwise a special operating condition is specified in the follows during the testing.

3.3.1.3 TEST SETUP

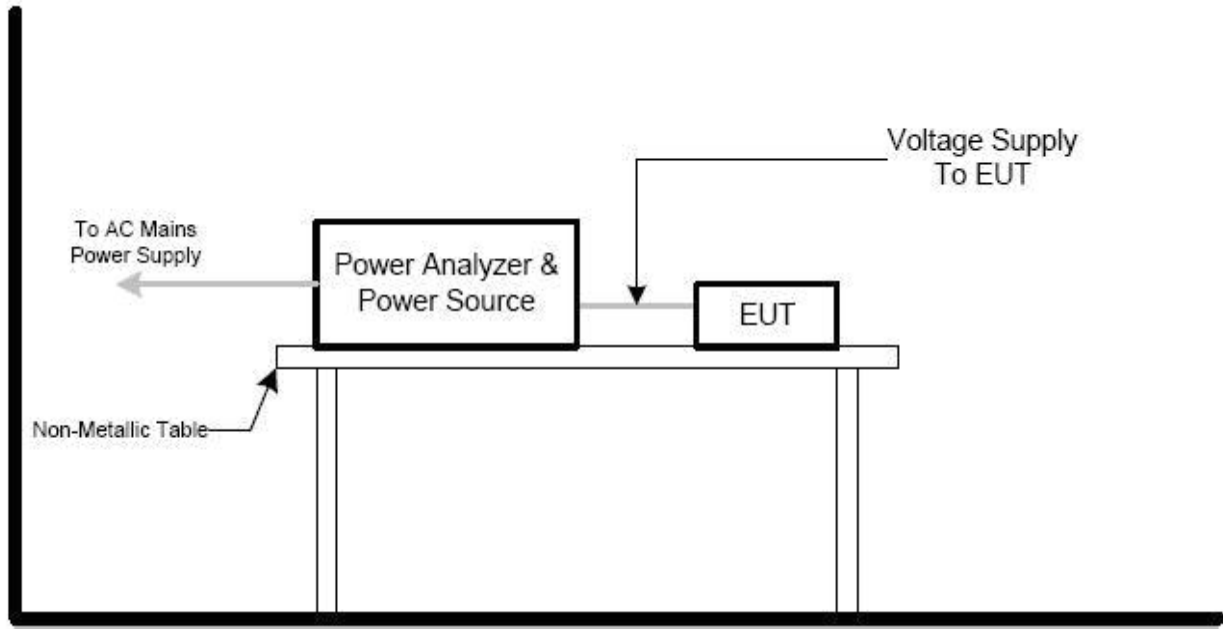



3.3.2 TEST RESULTS

EUT :	Car Air Pump	Model Name :	CZK-3668
Temperature :	N/A	Relative Humidity :	N/A
Pressure :	N/A	Test Date :	N/A
Test Mode :	N/A		
Test Power :	N/A		
Note: EUT is test by DC power supply, so this test report is not applicable.			



3.4 VOLTAGE FLUCTUATION AND FLICKERS

3.4.1 LIMITS OF VOLTAGE FLUCTUATION AND FLICKERS

Tests	Limits		Descriptions
	IEC555-3	IEC/EN 61000-3-3	
Pst	≤ 1.0, Tp= 10 min.	≤ 1.0, Tp= 10 min.	Short Term Flicker Indicator
Plt	N/A	≤ 0.65, Tp=2 hr.	Long Term Flicker Indicator
dc	≤ 3%	≤ 3.3%	Relative Steady-State V-Chang
dmax	≤ 4%	≤ 4%	Maximum Relative V-change
d (t)	N/A	≤ 3.3% for > 500 ms	Relative V-change characteristic

3.4.1.1 TEST PROCEDURE

a. Harmonic Current Test:

Test was performed according to the procedures specified in Clause 5.0 of IEC555-2 and/or Sub-clause 6.2 of IEC/EN 61000-3-2 depend on which standard adopted for compliance measurement.

b. Fluctuation and Flickers Test:

Tests was performed according to the Test Conditions/Assessment of Voltage Fluctuations specified in Clause 5.0/6.0 of IEC555-3 and/or Clause 6.0/4.0 of IEC/EN 61000-3-3 depend on which standard adopted for compliance measurement.

c. All types of harmonic current and/or voltage fluctuation in this report are assessed by direct measurement using flicker-meter.

3.4.1.2 EUT OPERATING CONDITIONS

The EUT tested system was configured as the statements of 2.3 Unless otherwise a special operating condition is specified in the follows during the testing.

3.4.1.3 TEST SETUP

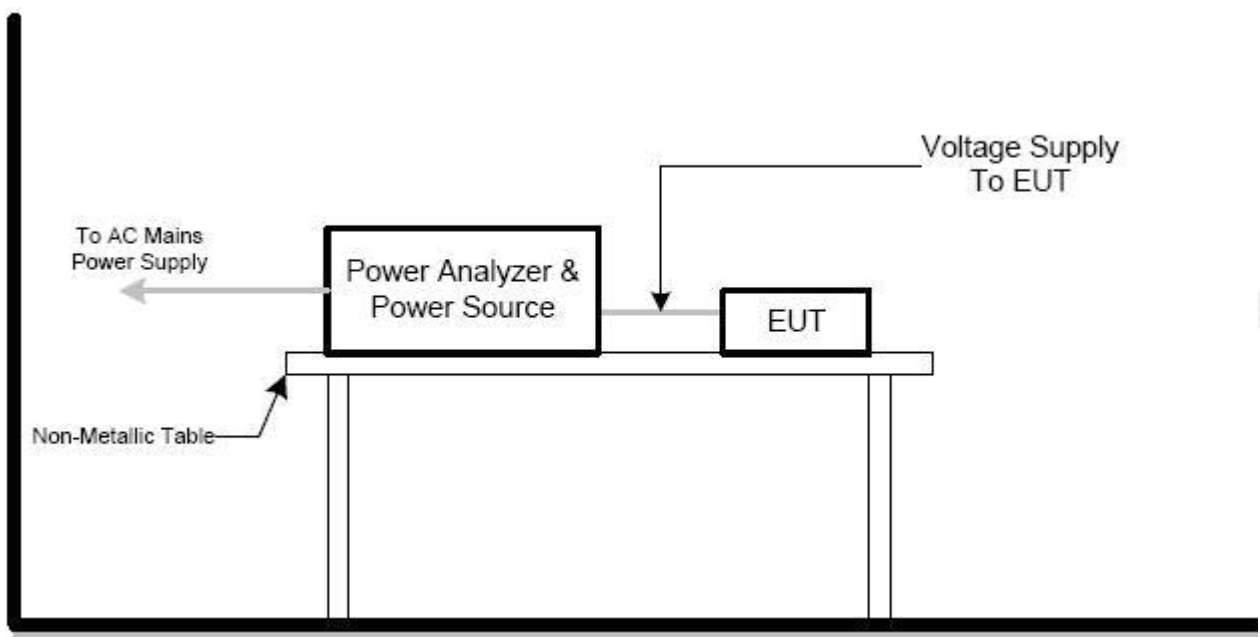



3.4.2 TEST RESULTS

EUT :	Car Air Pump	Model Name :	CZK-3668
Temperature :	N/A	Relative Humidity :	N/A
Pressure :	N/A	Test Date :	N/A
Test Mode :	N/A		
Test Power :	N/A		
Note: EUT is test by DC power supply, so this test report is not applicable.			

**4. EMC IMMUNITY TEST****4.1 STANDARD COMPLIANCE/SERVIRITY LEVEL/CRITERIA**

Tests Standard No.	TEST SPECIFICATION	Test Mode Test Ports	Perform. Criteria
1. ESD IEC/EN 61000-4-2	8KV air discharge 4KV contact discharge	Direct Mode	B
	4KV HCP discharge 4KV VCP discharge	Indirect Mode	B
2. RS IEC/EN 61000-4-3	80 MHz to 1000 MHz, 80%, AM modulated	Enclosure	A
3. EFT/Burst IEC/EN 61000-4-4	5/50ns Tr/Th 5KHz Repetition Freq.	Power Supply Port	B
	5/50ns Tr/Th 5KHz Repetition Freq.	CTL/Signal Data Line Port	B
4. Surges IEC/EN 61000-4-5	1.2/50(8/20) Tr/Th us	L-N	B
	1.2/50(8/20) Tr/Th us	L-PE N-PE	B
5 Injected currents IEC/EN 61000-4-6	0.15 MHz to 80 MHz, 1000Hz 80% , AM Modulated 150Ω source impedance	CTL/Signal Port	A
	0.15 MHz to 80 MHz, 1000Hz 80% , AM Modulated 150Ω source impedance	AC Power Port	A
	0.15 MHz to 80 MHz, 1000Hz 80% , AM Modulated 150Ω source impedance	DC Power Port	A
6. Volt. Interruptions Volt. Dips IEC/EN 61000-4-11	Voltage dip 0%	AC Power Port	C
	Voltage dip 30%		C
	Voltage dip 60%		C

The results shown in this test report refer only to the sample(s) tested unless otherwise stated and the sample(s) are retained for 30 days only. The document is issued by HUAK, this document cannot be reproduced except in full with our prior written permission. The more details and the authenticity of the report will be confirmed at <http://www.cer-mark.com>.

TEL : +86-755 2302 9901 FAX : +86-755 2302 9901 E-mail : service@cer-mark.com

Add: 1-2F., Building B2, Junfeng Zhongcheng Zhizao Innovation Park, Heping Community, Fuhai Street, Bao'an District, Shenzhen, Guangdong, China



4.2 GENERAL PERFORMANCE CRITERIA

According to **EN IEC 55014-2** standard, the general performance criteria as following:

Criterion A	<p>The equipment shall continue to operate as intended without operator intervention. No degradation of performance or loss of function is allowed below a performance level specified by the manufacturer when the equipment is used as intended.</p> <p>The performance level may be replaced by a permissible loss of performance. If the minimum performance level or the permissible performance loss is not specified by the manufacturer, then either of these may be derived from the product description and documentation, and by what the user may reasonably expect from the equipment if used as intended.</p>
Criterion B	<p>After the test, the equipment shall continue to operate as intended without operator intervention. No degradation of performance or loss of function is allowed, after the application of the phenomena below a performance level specified by the manufacturer, when the equipment is used as intended.</p> <p>The performance level may be replaced by a permissible loss of performance. During the test, degradation of performance is allowed. However, no change of operating state or stored data is allowed to persist after the test.</p>
Criterion C	<p>Loss of function is allowed, provided the function is self-recoverable, or can be restored by the operation of the controls by the user in accordance with the manufacturer's instructions.</p> <p>Functions, and/or information stored in non-volatile memory, or protected by a battery backup, shall not be lost.</p>

4.3 GENERAL PERFORMANCE CRITERIA TEST SETUP

The EUT tested system was configured as the statements of **2.3** Unless otherwise a special operating condition is specified in the follows during the testing.



4.4 ESD TESTING

4.4.1 TEST SPECIFICATION

Basic Standard:	IEC/EN 61000-4-2
Discharge Impedance:	330 ohm / 150 pF
Required Performance	B
Discharge Voltage:	Air Discharge : 2kV/4kV/8kV (Direct) Contact Discharge : 2kV/4kV (Direct/Indirect)
Polarity:	Positive & Negative
Number of Discharge:	Air Discharge: min. 20 times at each test point Contact Discharge: min. 20 at each test point
Discharge Mode:	Single Discharge
Discharge Period:	1 second minimum

4.4.2 TEST PROCEDURE

The test generator necessary to perform direct and indirect application of discharges to the EUT in the following manner:

- a. Contact discharge was applied to conductive surfaces and coupling planes of the EUT. During the test, it was performed with single discharges. For the single discharge time between successive single discharges was at least 1 second. The EUT shall be exposed to at least 200 discharges, 100 each at negative and positive polarity, at a minimum of four test points. One of the test points shall be subjected to at least 50 indirect discharges to the center of the front edge of the horizontal coupling plane. The remaining three test points shall each receive at least 50 direct contact discharges.

If no direct contact test points are available, then at least 200 indirect discharges shall be applied in the indirect mode. Test shall be performed at a maximum repetition rate of one discharge per second.

Vertical Coupling Plane (VCP):

The coupling plane, of dimensions 0.5m x 0.5m, is placed parallel to, and positioned at a distance 0.1m from, the EUT, with the Discharge Electrode touching the coupling plane. The four faces of the EUT will be performed with electrostatic discharge.

Horizontal Coupling Plane (HCP):

The coupling plane is placed under to the EUT. The generator shall be positioned vertically at a distance of 0.1m from the EUT, with the Discharge Electrode touching the coupling plane. The four faces of the EUT will be performed with electrostatic discharge.

- b. Air discharges at insulation surfaces of the EUT.

It was at least ten single discharges with positive and negative at the same selected point.

4.4.3 TEST SETUP

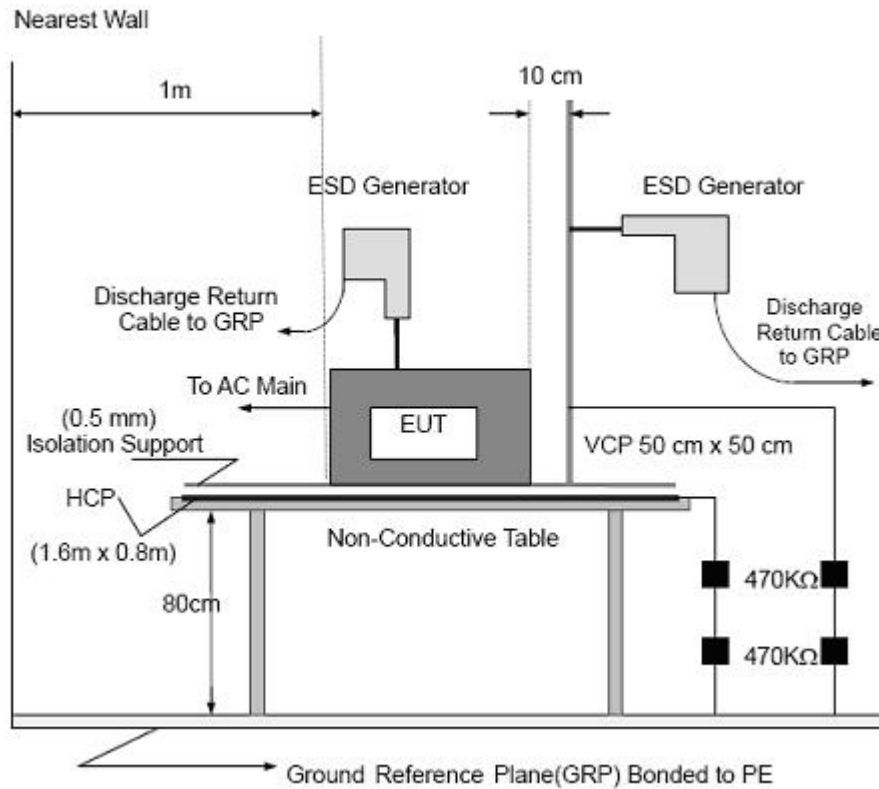

Note:

TABLE-TOP EQUIPMENT

The configuration consisted of a wooden table 0.8 meters high standing on the Ground Reference Plane. The GRP consisted of a sheet of aluminum at least 0.25mm thick, and 2.5 meters square connected to the protective grounding system. A Horizontal Coupling Plane (1.6m x 0.8m) was placed on the table and attached to the GRP by means of a cable with 940k total impedance. The equipment under test, was installed in a representative system as described in section 7 of IEC /EN 61000-4-2, and its cables were placed on the HCP and isolated by an insulating support of 0.5mm thickness. A distance of 1-meter minimum was provided between the EUT and the walls of the laboratory and any other metallic structure.

FLOOR-STANDING EQUIPMENT

The equipment under test was installed in a representative system as described in section 7 of IEC/EN 61000-4-2, and its cables were isolated from the Ground Reference Plane by an insulating support of 0.1-meter thickness. The GRP consisted of a sheet of aluminum that is at least 0.25mm thick, and 2.5meters square connected to the protective grounding system and extended at least 0.5 meters from the EUT on all sides.



4.4.4 TEST RESULTS

EUT :	Car Air Pump	Model Name :	CZK-3668
Temperature :	24 °C	Relative Humidity :	45%
Pressure :	1010 hPa	Test Date :	2024-02-22
Test Mode :	Mode 1		
Test Power :	DC 5V From Type-C		

Mode	Air Discharge								Contact Discharge								Criterion	Result
	4		8		10		15		2		4		6		8			
Test level (kV)																		
Test Location	+	-	+	-	+	-	+	-	+	-	+	-	+	-	+	-		
HCP									A	A	A	A					B	PASS
VCP									A	A	A	A						PASS
Metallic parts									/	/	/	/						N/A
enclosure	A	A	A	A														PASS
slot	A	A	A	A														PASS

Note:

- 1) +/- denotes the Positive/Negative polarity of the output voltage.
- 2) Test condition:
Direct / Indirect (HCP/VCP) discharges: Minimum 50 times (Positive/Negative) at each point. Air discharges: Minimum 10 times (Positive/Negative) at each point.
- 3) Test location(s) in which discharge (Air and contact discharge) to be applied illustrated by photos shown in next page(s)
- 4) The Indirect (HCP/VCP) discharges description of test point as following:
1.left side 2.right side 3.front side 4.rear side
- 5) N/A - denotes test is not applicable in this test report



4.5 RS TESTING

4.5.1 TEST SPECIFICATION

Basic Standard:	IEC/EN 61000-4-3
Required Performance	A
Frequency Range:	80 MHz - 1000 MHz, 1400 -2000MHz, 2000-2700MHz
Field Strength:	3 V/m, 1V/m
Modulation:	1kHz Sine Wave, 80%, AM Modulation
Frequency Step:	1 % of fundamental
Polarity of Antenna:	Horizontal and Vertical
Test Distance:	3 m
Antenna Height:	1.5 m
Dwell Time:	at least 3 seconds

4.5.2 TEST PROCEDURE

The EUT and support equipment, which are placed on a table that is 0.8 meter above ground and the testing was performed in a fully-anechoic chamber.

The testing distance from antenna to the EUT was 3 meters.

The other condition as following manner:

- a. The frequency range is swept from 80 MHz to 1000 MHz, & 1400MHz - 2700MHz with the signal 80%amplitude modulated with a 1kHz sine wave. The rate of sweep did not exceed 1.5x 10-3 decade/s. Where the frequency range is swept incrementally, the step size was 1% of fundamental.
- b. Sweep Frequency 900 MHz, with the Duty Cycle:1/8 and Modulation: Pulse 217 Hz(if applicable)
- c. The dwell time at each frequency shall be not less than the time necessary for the EUT to be able to respond.
- d. The test was performed with the EUT exposed to both vertically and horizontally polarized fields on each of the four sides.

4.5.3 TEST SETUP

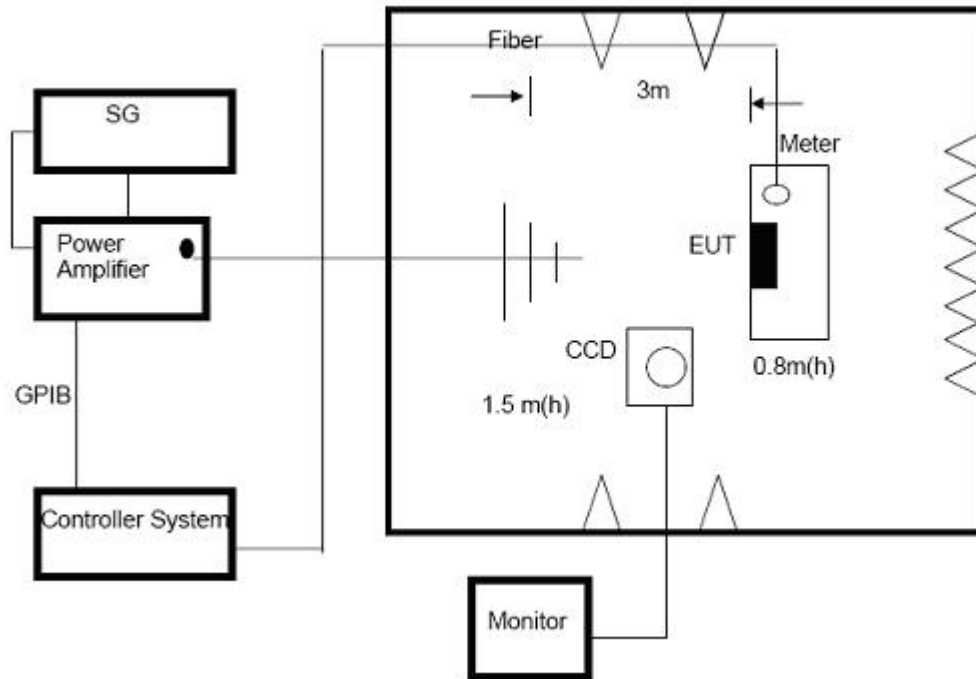

Note:

TABLE-TOP EQUIPMENT

The EUT installed in a representative system as described in section 7 of IEC/EN 61000-4-3 was placed on a non-conductive table 0.8 meters in height. The system under test was connected to the power and signal wire according to relevant installation instructions.

FLOOR-STANDING EQUIPMENT

The EUT installed in a representative system as described in section 7 of IEC/EN 61000-4-3 was placed on a non-conductive wood support 0.1 meters in height. The system under test was connected to the power and signal wire according to relevant installation instructions.



4.5.4 TEST RESULTS

EUT :	Car Air Pump	Model Name :	CZK-3668
Temperature :	24 °C	Relative Humidity :	52%
Pressure :	1010 hPa	Test Date :	2024-02-22
Test Mode :	Mode 1		
Test Power :	DC 5V From Type-C		

Frequency Range (MHz)	RF Field Position	R.F. Field Strength	Azimuth	Perform. Criteria	Results	Judgment
80MHz - 1000MHz	H / V	3 V/m (rms) AM Modulated 1000Hz, 80%	Front	A	A	PASS
			Rear			
			Left			
			Right			

Note:

- 1) N/A - denotes test is not applicable in this test report.
- 2) Criteria A: There was no change operated with initial operating during the test.
- 3) Criteria B: The EUT function loss during the test, but self-recoverable after the test.
- 4) Criteria C: The system shut down during the test.



4.6 EFT/BURST TESTING

4.6.1 TEST SPECIFICATION

Basic Standard:	IEC/EN 61000-4-4
Required Performance	B
Test Voltage:	Power Line : 1 kV Signal/Control Line : 0.5 KV
Polarity:	Positive & Negative
Impulse Frequency:	5 kHz
Impulse Wave shape :	5/50 ns
Burst Duration:	15 ms
Burst Period:	300 ms
Test Duration:	Not less than 1 min.

4.6.2 TEST PROCEDURE

The EUT and support equipment, are placed on a table that is 0.8 meter above a metal ground plane measured 1m*1m min. and 0.65mm thick min.

The other condition as following manner:

- a. The length of power cord between the coupling device and the EUT should not exceed 1 meter.
- b. Both positive and negative polarity discharges were applied.
- c. The duration time of each test sequential was 1 minute

4.6.3 TEST SETUP

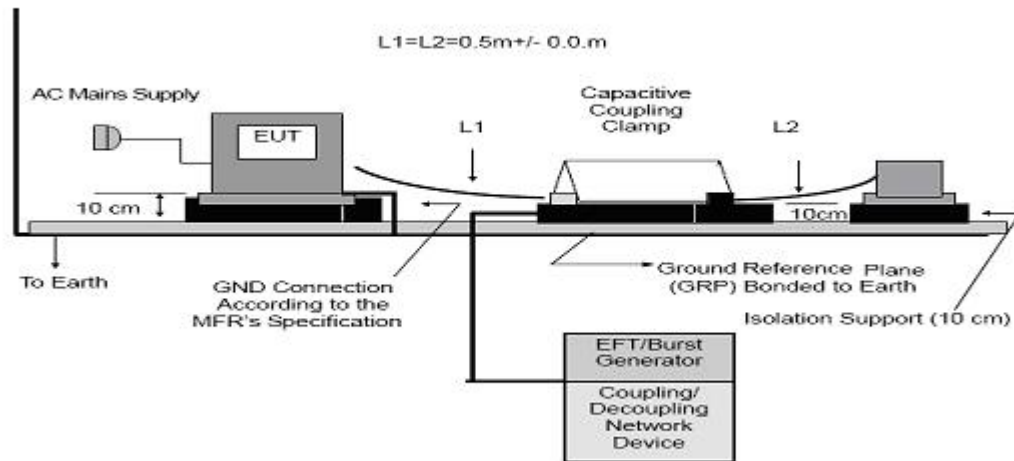
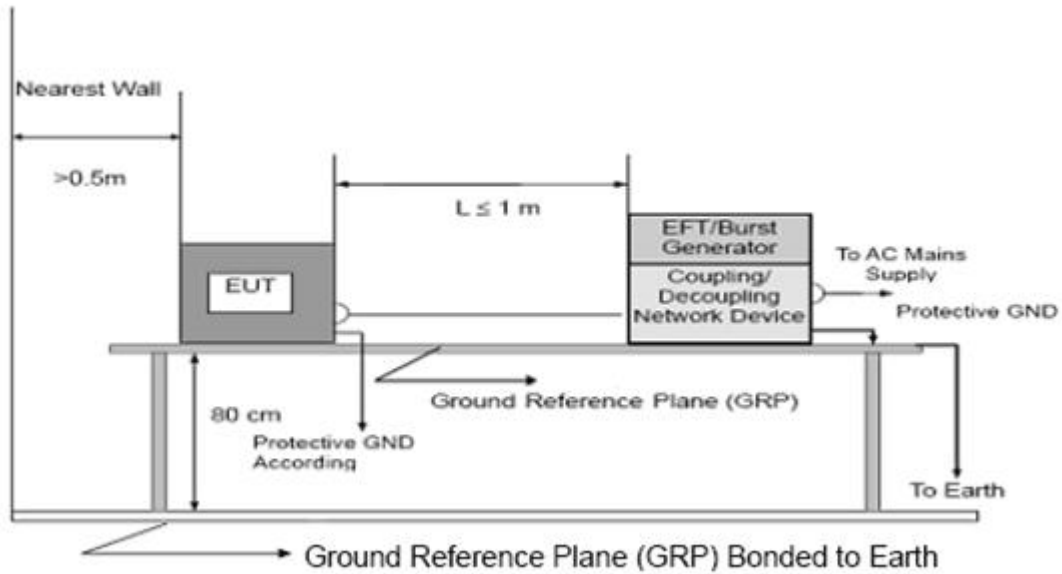

Note:

TABLE-TOP EQUIPMENT

The configuration consisted of a wooden table (0.8m high) standing on the Ground Reference Plane. The GRP consisted of a sheet of aluminum (at least 0.25mm thick and 2.5m square) connected to the protective grounding system. A minimum distance of 0.5m was provided between the EUT and the walls of the laboratory or any other metallic structure.

FLOOR-STANDING EQUIPMENT

The EUT installed in a representative system as described in section 7 of IEC/EN 61000-4-4 and its cables, were isolated from the Ground Reference Plane by an insulating support that is 0.1-meter thick. The GRP consisted of a sheet of aluminum (at least 0.25mm thick and 2.5m square) connected to the protective grounding system.



4.6.4 TEST RESULTS

EUT :	Car Air Pump	Model Name :	CZK-3668
Temperature :	N/A	Relative Humidity :	N/A
Pressure :	N/A	Test Date :	N/A
Test Mode :	N/A		
Test Power :	N/A		
Note: EUT is test by DC power supply, so this test report is not applicable.			



4.7 SURGE TESTING

4.7.1 TEST SPECIFICATION

Basic Standard:	IEC/EN 61000-4-5
Required Performance	B
Wave-Shape:	Combination Wave 1.2/50 us Open Circuit Voltage 8 /20 us Short Circuit Current
Test Voltage:	Power Line : 0.5 kV, 1 kV, 2 kV
Surge Input/Output:	L-N, L-PE, N-PE
Generator Source:	2 ohm between networks
Impedance:	12 ohm between network and ground
Polarity:	Positive/Negative
Phase Angle:	0 /90/180/270°
Pulse Repetition Rate:	1 time / min. (maximum)
Number of Tests:	5 positive and 5 negative at selected points

4.7.2 TEST PROCEDURE

a. For EUT power supply:

The surge is to be applied to the EUT power supply terminals via the capacitive coupling network. Decoupling networks are required in order to avoid possible adverse effects on equipment not under test that may be powered by the same lines, and to provide sufficient decoupling impedance to the surge wave. The power cord between the EUT and the coupling/decoupling networks shall be 2meters in length (or shorter).

b. For test applied to unshielded unsymmetrically operated interconnection lines of EUT:

The surge is applied to the lines via the capacitive coupling. The coupling /decoupling networks shall not influence the specified functional conditions of the EUT. The interconnection line between the EUT and the coupling/decoupling networks shall be 2 meters in length (or shorter).

c. For test applied to unshielded symmetrically operated interconnection /telecommunication lines of EUT:

d. The surge is applied to the lines via gas arrestors coupling. Test levels below the ignition point of the coupling arrestor cannot be specified. The interconnection line between the EUT and the coupling/decoupling networks shall be 2 meters in length (or shorter).



4.7.3 TEST SETUP

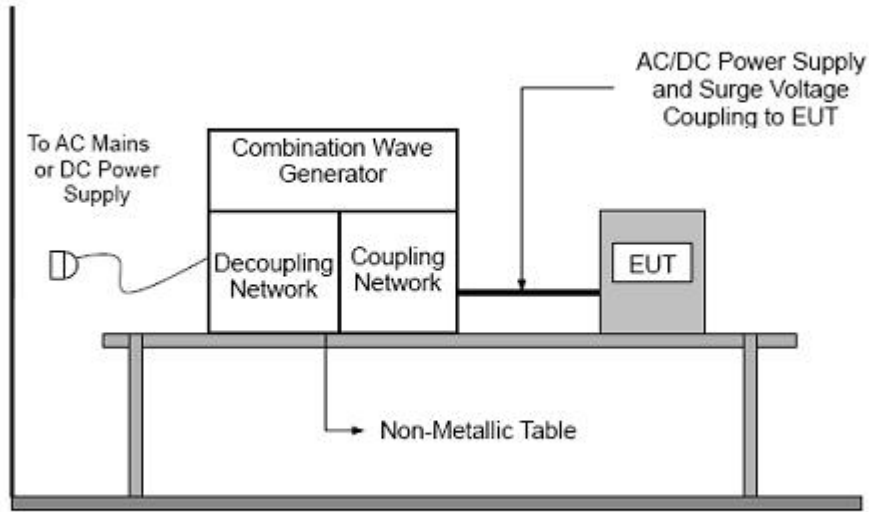

The results shown in this test report refer only to the sample(s) tested unless otherwise stated and the sample(s) are retained for 30 days only. The document is issued by HUAK, this document cannot be reproduced except in full with our prior written permission. The more details and the authenticity of the report will be confirmed at <http://www.cer-mark.com>.

TEL : +86-755 2302 9901 FAX : +86-755 2302 9901 E-mail : service@cer-mark.com

Addr: 1-2F., Building B2, Junfeng Zhongcheng Zhizao Innovation Park, Heping Community, Fuhai Street, Bao'an District, Shenzhen, Guangdong, China



4.7.4 TEST RESULTS

EUT :	Car Air Pump	Model Name :	CZK-3668
Temperature :	N/A	Relative Humidity :	N/A
Pressure :	N/A	Test Date :	N/A
Test Mode :	N/A		
Test Power :	N/A		
Note: EUT is test by DC power supply, so this test report is not applicable.			



4.8 INJECTION CURRENT TESTING

4.8.1 TEST SPECIFICATION

Basic Standard:	IEC/EN 61000-4-6
Required Performance	A
Frequency Range:	0.15 MHz - 80 MHz
Field Strength:	3 Vr.m.s.
Modulation:	1kHz Sine Wave, 80%, AM Modulation
Frequency Step:	1 % of fundamental
Dwell Time:	at least 3 seconds

4.8.2 TEST PROCEDURE

The EUT and support equipment, are placed on a table that is 0.8 meter above a metal ground plane measured 1m*1m min. and 0.65mm thick min.

The other condition as following manner:

- a. The frequency range is swept from 150 KHz to 80 MHz, with the signal 80%amplitude modulated with a 1kHz sine wave. The rate of sweep did not exceed 1.5×10^{-3} decade/s. Where the frequency range is swept incrementally, the step size was 1% of fundamental.
- b. The dwell time at each frequency shall be not less than the time necessary for the EUT to be able to respond.

4.8.3 TEST SETUP

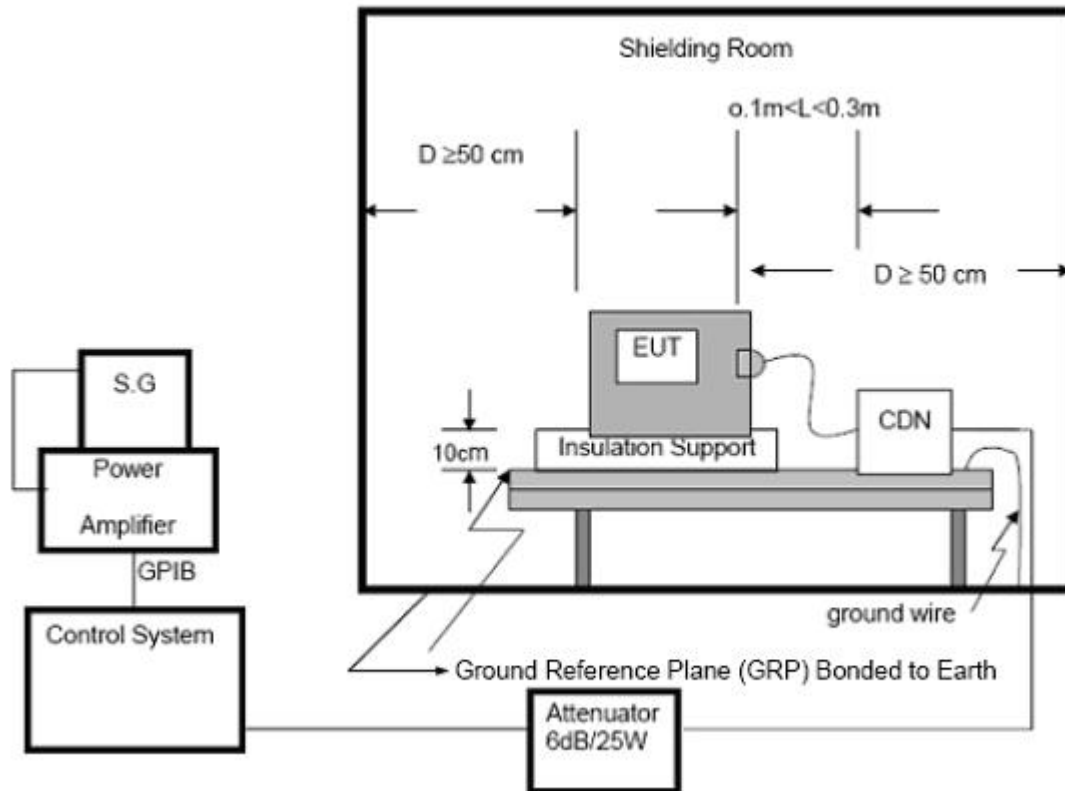
**NOTE:****FLOOR-STANDING EQUIPMENT**

The equipment to be tested is placed on an insulating support of 0.1 meters height above a ground reference plane. All relevant cables shall be provided with the appropriate coupling and decoupling devices at a distance between 0.1 meters and 0.3 meters from the projected geometry of the EUT on the ground reference plane.



4.8.4 TEST RESULTS

EUT :	Car Air Pump	Model Name :	CZK-3668
Temperature :	N/A	Relative Humidity :	N/A
Pressure :	N/A	Test Date :	N/A
Test Mode :	N/A		
Test Power :	N/A		
Note: EUT is test by DC power supply, so this test report is not applicable.			

4.9 VOLTAGE INTERRUPTION/DIPS TESTING

4.9.1 TEST SPECIFICATION

Basic Standard:	IEC/EN 61000-4-11
Required Performance	C (For 0% Voltage Dips) C (For 30% Voltage Dips) C (For 60% Voltage Dips)
Test Duration Time:	Minimum three test events in sequence
Interval between Event:	Minimum ten seconds
Phase Angle:	0°/45°/90°/135°/180°/225°/270°/315°/360°
Test Cycle:	3 times

4.9.2 TEST PROCEDURE

The EUT shall be tested for each selected combination of test levels and duration with a sequence of three dips/interruptions with intervals of 10 s minimum (between each test event). Each representative mode of operation shall be tested. Abrupt changes in supply voltage shall occur at zero crossings of the voltage waveform.

4.9.3 TEST SETUP

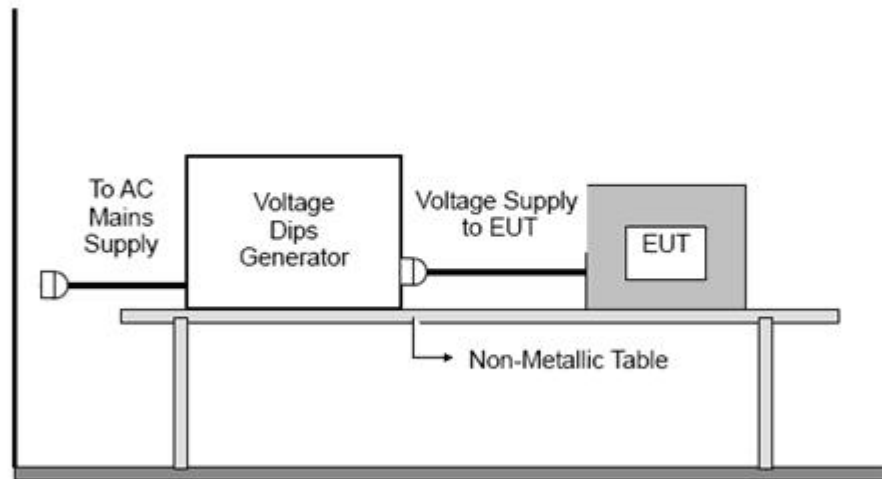



4.9.4 TEST RESULTS

EUT :	Car Air Pump	Model Name :	CZK-3668
Temperature :	N/A	Relative Humidity :	N/A
Pressure :	N/A	Test Date :	N/A
Test Mode :	N/A		
Test Power :	N/A		
Note: EUT is test by DC power supply, so this test report is not applicable.			



5. EUT TEST PHOTO

Disturbance Power



Radiated Emission

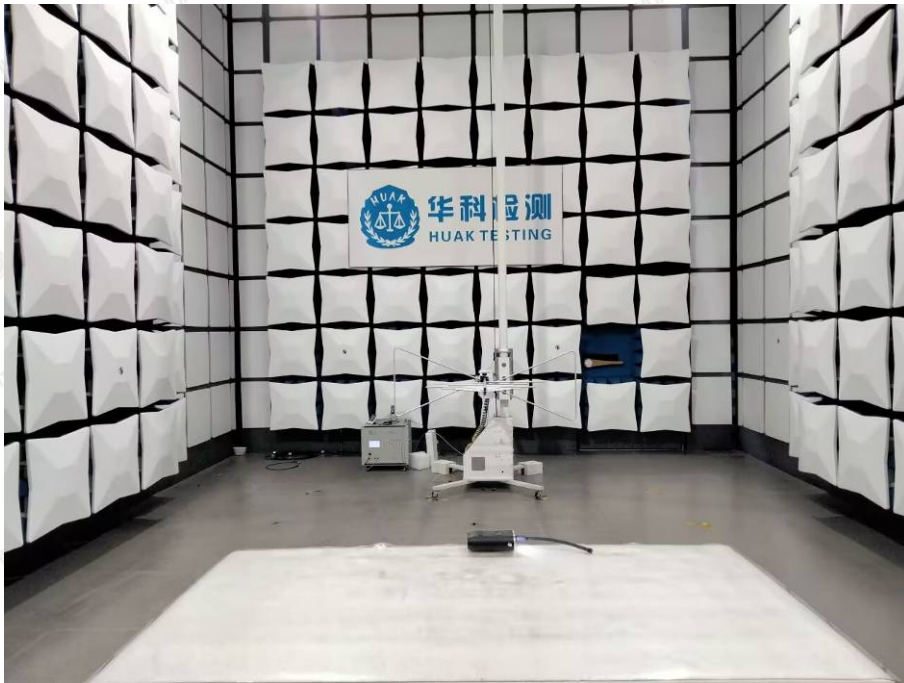

The results shown in this test report refer only to the sample(s) tested unless otherwise stated and the sample(s) are retained for 30 days only. The document is issued by HUAK, this document cannot be reproduced except in full with our prior written permission. The more details and the authenticity of the report will be confirmed at <http://www.cer-mark.com>.

TEL : +86-755 2302 9901 FAX : +86-755 2302 9901 E-mail : service@cer-mark.com

Addr: 1-2F., Building B2, Junfeng Zhongcheng Zhizao Innovation Park, Heping Community, Fuhai Street, Bao'an District, Shenzhen, Guangdong, China



Electrostatic Discharge



The results shown in this test report refer only to the sample(s) tested unless otherwise stated and the sample(s) are retained for 30 days only. The document is issued by HUAK, this document cannot be reproduced except in full with our prior written permission. The more details and the authenticity of the report will be confirmed at <http://www.cer-mark.com>.

TEL : +86-755 2302 9901 FAX : +86-755 2302 9901 E-mail : service@cer-mark.com

Addr: 1-2F., Building B2, Junfeng Zhongcheng Zhizao Innovation Park, Heping Community, Fuhai Street, Bao'an District, Shenzhen, Guangdong, China



ATTACHMENT PHOTOGRAPHS OF EUT

Photo 1



Photo 2





Photo 3



Photo 4





Photo 5



Photo 6



Photo 7



Photo 8





Photo 9

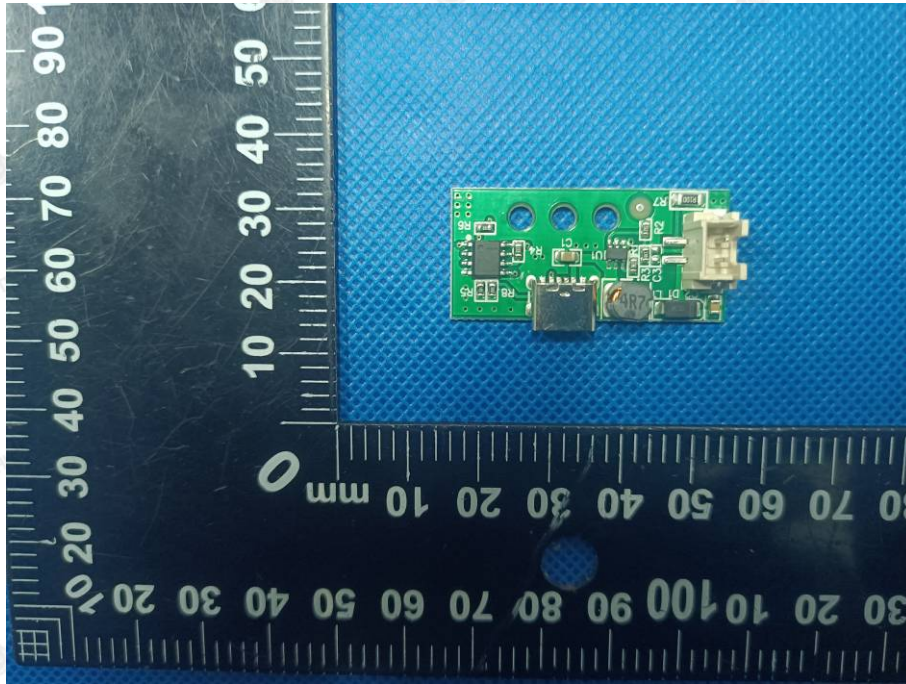
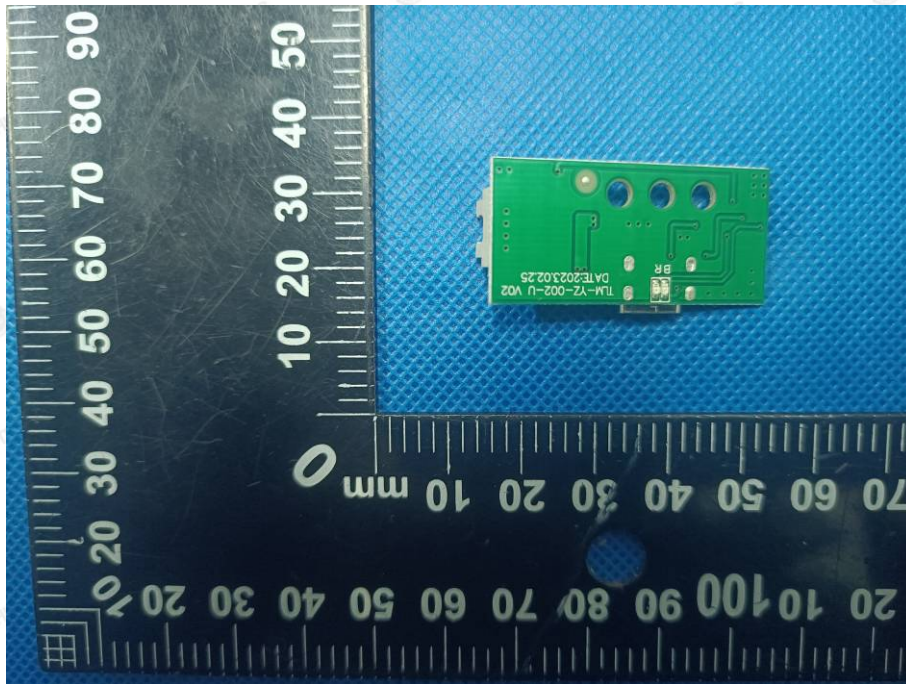

Photo 10



The results shown in this test report refer only to the sample(s) tested unless otherwise stated and the sample(s) are retained for 30 days only. The document is issued by HUAK, this document cannot be reproduced except in full with our prior written permission. The more details and the authenticity of the report will be confirmed at <http://www.cer-mark.com>.

TEL : +86-755 2302 9901 FAX : +86-755 2302 9901 E-mail : service@cer-mark.com

Addr: 1-2F., Building B2, Junfeng Zhongcheng Zhizao Innovation Park, Heping Community, Fuhai Street, Bao'an District, Shenzhen, Guangdong, China

Photo 11

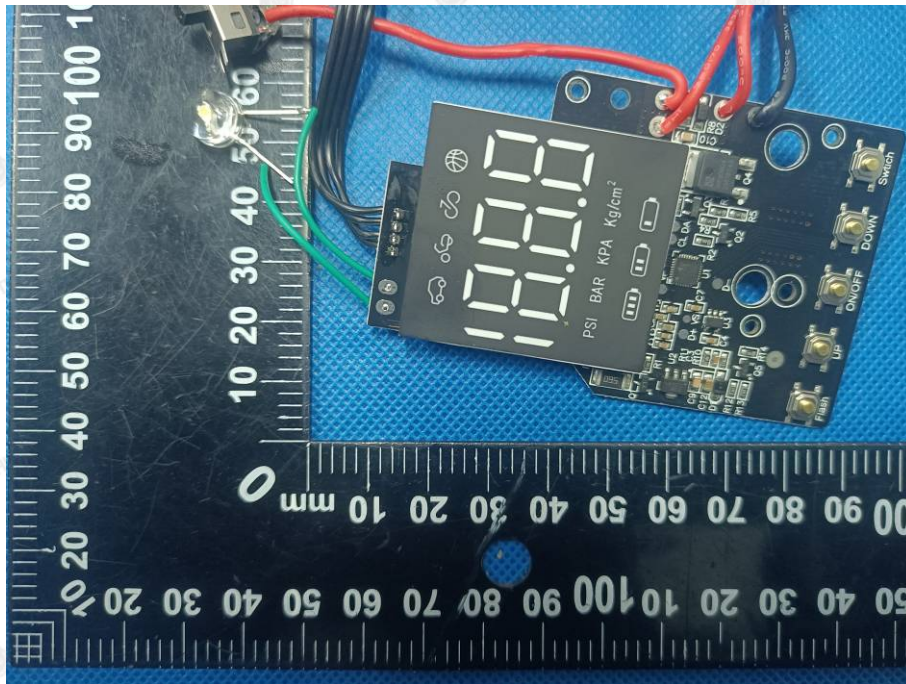

Photo 12

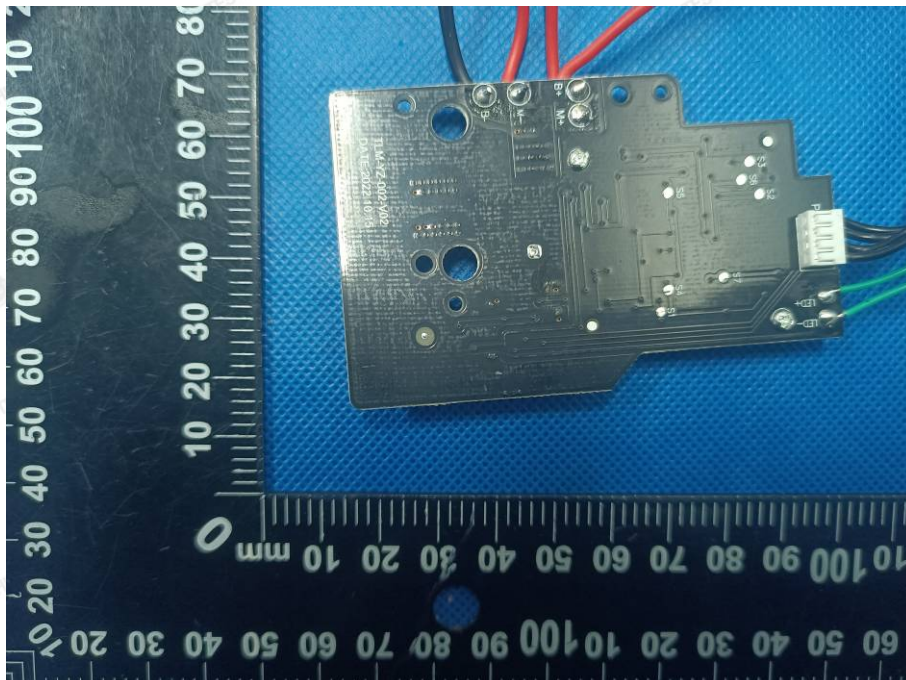
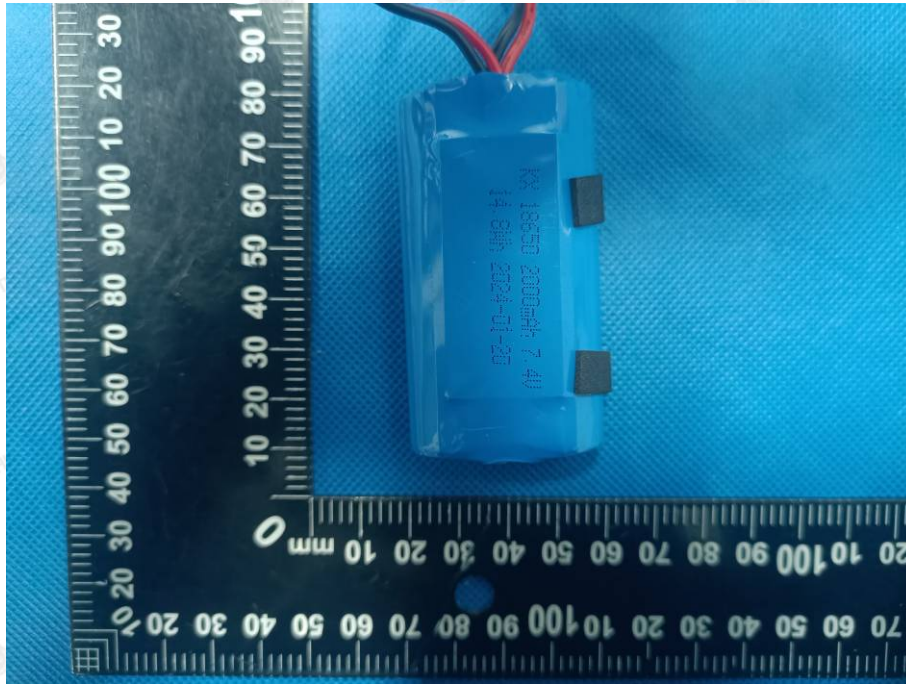



Photo 13



※※End of Report※※